

YAZAWA

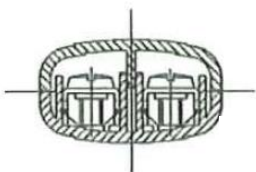
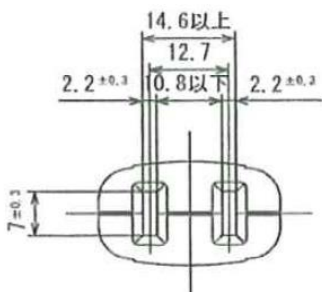
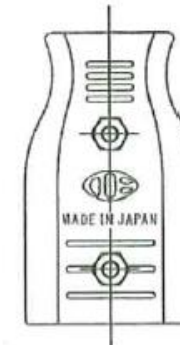
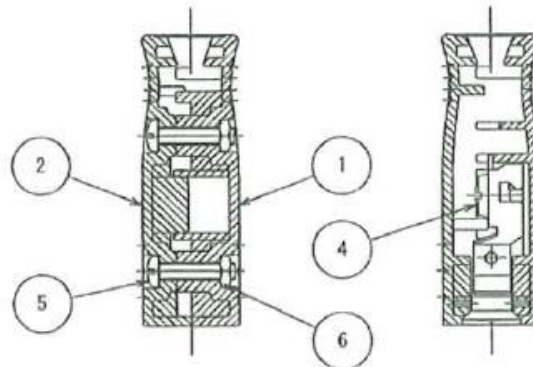
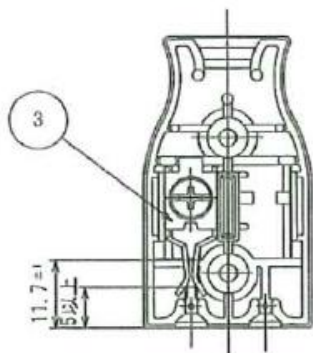
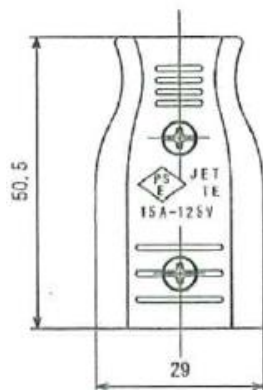
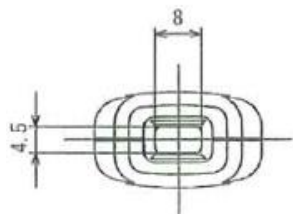

6	六角ナット	2	00000427	SWRM	M3	MF3ZnC	3種
5	(鋼)小ネジ	2	00000065	SWRM	M3 × 13	MF3ZnC	
4	大頭丸平小ネジ	2	00000005	C2600W	M3.5 × 6	DP	
3	刃受端子	2	30860200	C2680R-H	t=0.8	DP	
2	蓋側	1	30970030	PVC樹脂	理研ビニル工業(株)RJ-4080同等品		
1	台側	1	30970020	PVC樹脂	理研ビニル工業(株)RJ-4080同等品		
NO.	部品名 NAME OF PARTS	数量 QUANTITY	部品番号 PARTS NO.	材質 MATERIALS	寸度 DIMENSIONS	仕上 FINISH	適要 REMARKS

型番	SF4615CL
品名	コンセントポディークリア
株式会社ヤザワコーポレーション	